

1 **A**

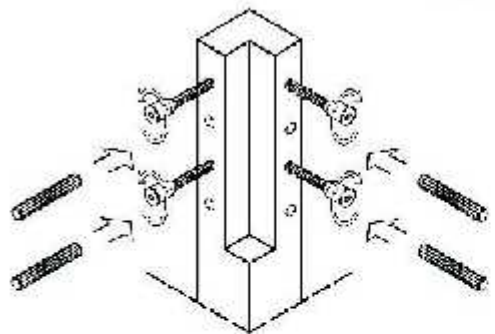

2 **A**

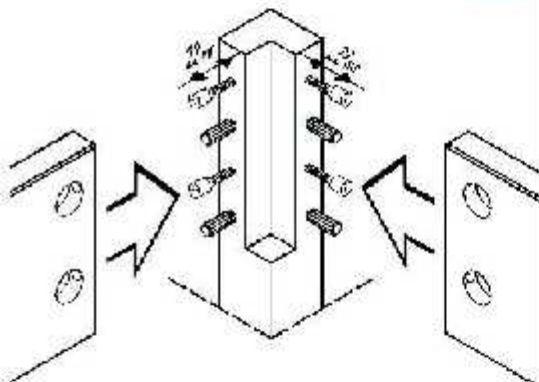

3 **A**

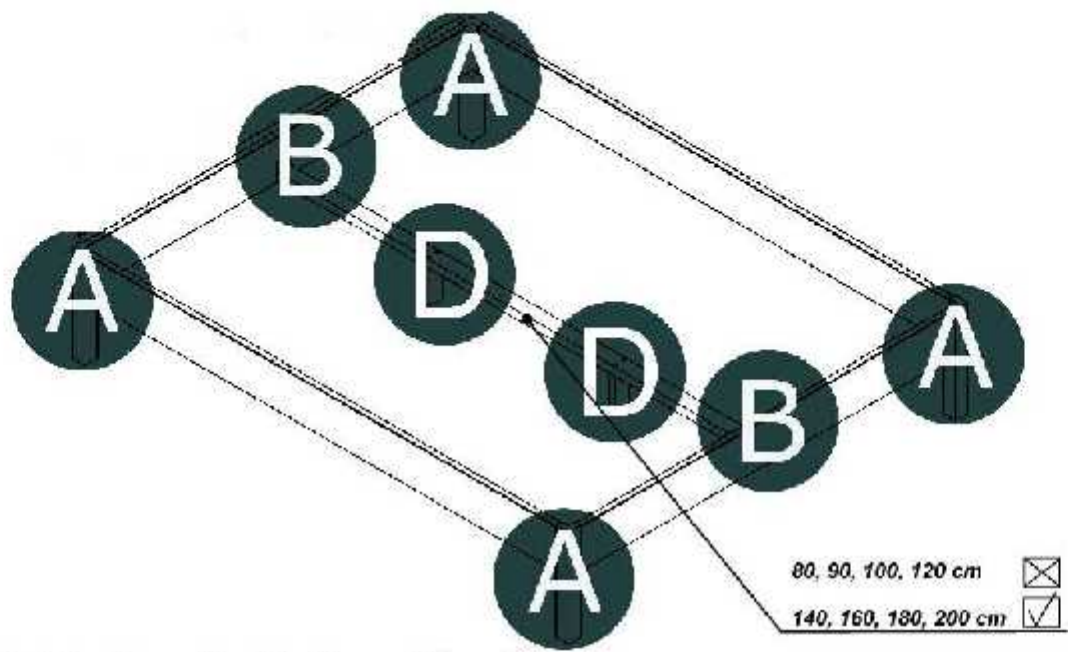
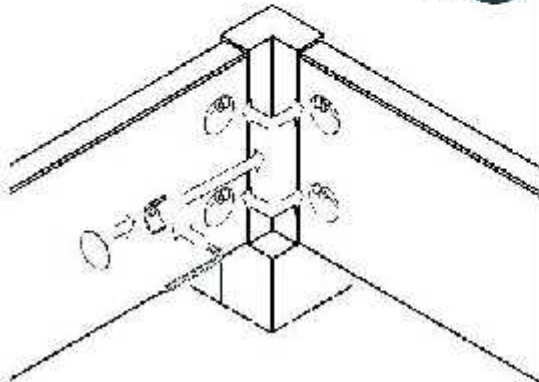





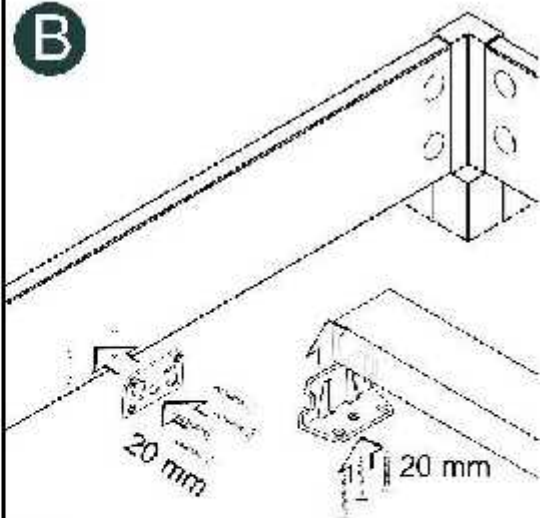



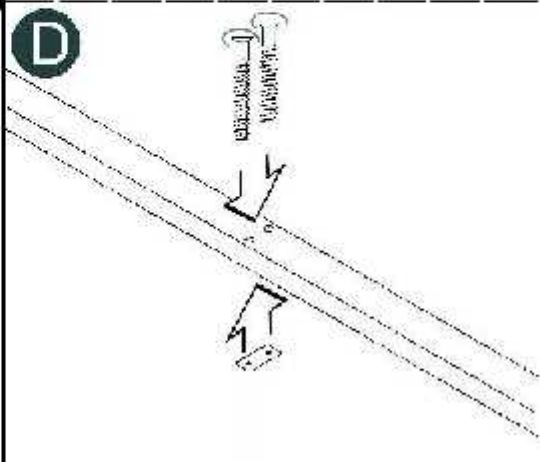

VENTO

B



D



- | | | | |
|---|--|---|---|
|  |  |  |  |
| x 16 | x 16 | x 16 | x 14 |
|  |  |  |  |
| x 2 | x 2 | x 4 | x 16 |
| | | $\varnothing 10 \times 40 \text{ mm}$ | $\varnothing 4 \times 20 \text{ mm}$ |
| | | $\varnothing 6,5 \times 50$ | $\varnothing 7 \times 50 \text{ mm}$ |
| | | | s = 4 |
| | | |  |
| | | | x 1 |